

AIR CONDITIONING
CLIMATISATION

ARTICON LINE



All rights reserved. No part of this catalogue may be reproduced or transmitted in any form without prior permission. Specifications, colours and any other information herewith included are subject to change without notice. All mentioned logos are registered logos and belong to their lawful owners.

La reproduction partielle de ce catalogue est interdite. Canalplast S.p.A. se réserve le droit de modifier les prix et les spécifications produits répertoriés dans ce catalogue sans préavis. Tous les logos et marques déposées mentionnées sont la propriété de leurs propriétaires respectifs.

PRESENTATION

PRÉSENTATION

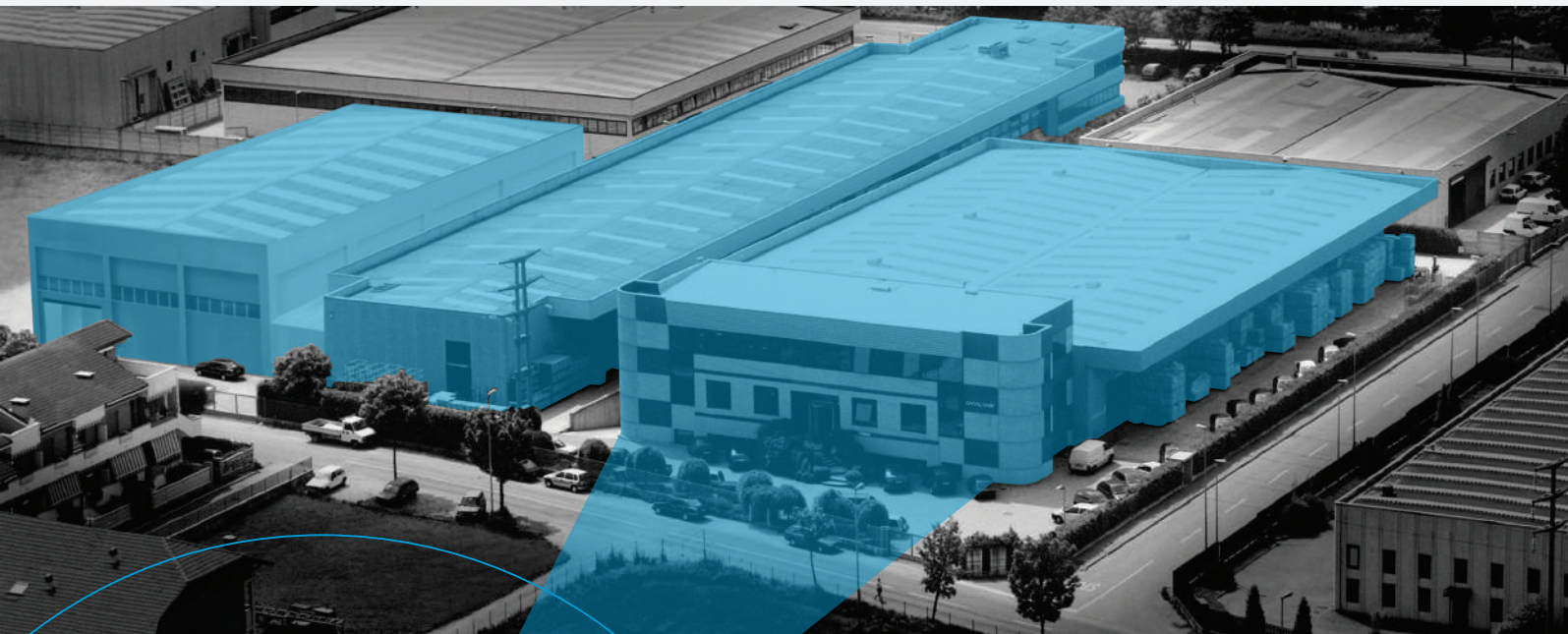

CANALPLAST, since more than 50 years, is specialised in the production and development of plastic trunking systems for installation.

CANALPLAST is placed in Limbiate (close to Milano, Italy) and its facilities cover an area of 20.000 m2. We are proud to serve more than 60 countries in all over the world offering more of 1500 different products.

CANALPLAST, depuis de 50 ans, est spécialisée dans la production et le développement de systèmes de goulottes en plastique pour l'installation.

CANALPLAST est placé à Limbiate (près de Milan, Italie) et ses installations couvrent une superficie de 20.000 m2. Nous sommes fiers de servir plus de 60 pays dans le monde entier en offrant plus de 1500 produits différents.



INDEX

INDEX

LEGEND LÉGENDE



CODE
RÉFÉRENCE



DIMENSIONS
MESURES



QUANTITY
QUANTITÉ



INFORMATION
INFORMATION



AREA MQ²
SURFACE MQ²



SUPPORTED WEIGHT
CAPACITÉ DE POIDS



PALLET QUANTITY
QUANTITÉ DE PALETTES



MT PALLET
PALETTE MT

TRUNKINGS AND ACCESSORIES

GOULOTTES ET ACCESSOIRES



6

TRUNKING WITH WRAP AROUND COVER

GOULOTTE ENVELOPPANTE

PRESET FOR AIR CONDITIONING INSTALLATIONS

PRÉPARATION POUR SYSTÈMES DE CLIMATISATION



14

PRESET BOXES AND SIPHONS

BOITES DE PRÉPARATION ET SIPHONS

SUPPORTS FOR EXTERNAL AIR CONDITIONING SECTION AND ACCESSORIES

SOUTIENS POUR L'UNITÉ EXTÉRIEURE ET ACCESSOIRES



18

FLOOR SUPPORT

SUPPORTS DE PLANCHER

SUMMARY

RÉSUMÉ



20

TRUNKING ACCESSORIES SUMMARY

RÉSUMÉ DES ACCESSOIRES



8 TRUNKING WITH
SNAP ON COVER
GOULOTTE COUVERCLE A DÉCLIC

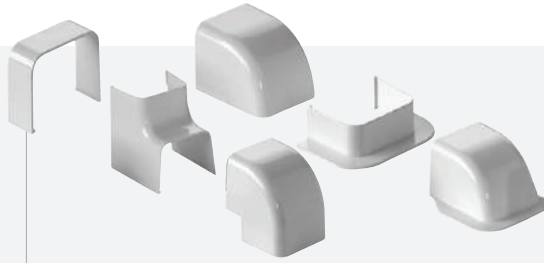

10 TRUNKING ACCESSORIES
ACCESSOIRES POUR GOULOTTES

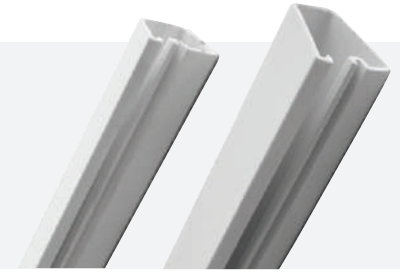

13 MINITRUNKINGS
MOULURES



15 RIGID PIPES
AND ACCESSORIES
TUYAUX RIGIDES ET ACCESSOIRES



16 FLEXIBLE PIPE AND ACCESSORIES
TUYAU FLEXIBLE ET ACCESSOIRES



17 SPIRAL PIPE AND ACCESSORIES
TUYAU SPIRALÉ ET ACCESSOIRES



18 WALL BRACKETS
SUPPORTS À MUR

GENERAL CONDITIONS

CONDITIONS GÉNÉRALES

WRAP AROUND LINE | TRUNKING WITH WRAP AROUND COVER

WRAP AROUND LINE | GOULOTTE ENVELOPPANTE

Self-extinguishing PVC, UV stabilized Class 1 (UL94-V0)
PVC auto-extinguible, Stabilisé UV Classe 1 (UL94-V0)

ARTICON wrap around line is the ideal trunking for completing internal and external air conditioning system. Practicality and compactness are the main characteristics. Available in 5 different sizes for MONO and MULTISPLIT air conditioning units. Length 2 mt.

All trunkings are equipped with protective film.

ARTICON wrap around line est la goulotte idéale pour la réalisation de systèmes de climatisation d'air internes et externes. Compacité et praticité sont les principales caractéristiques. Disponible en 5 tailles pour systèmes MONO et MULTISPLIT. Longueur 2 mt.

Tous les goulottes sont munis d'un film de protection.

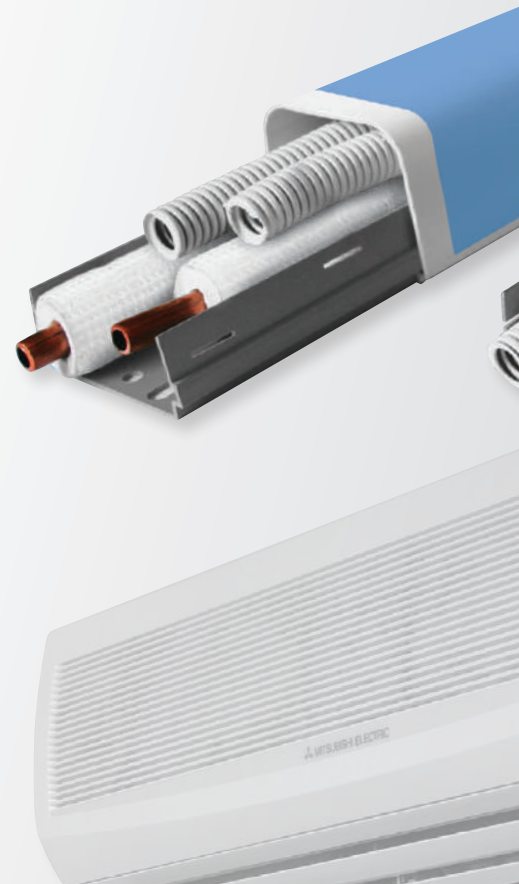

CON65A

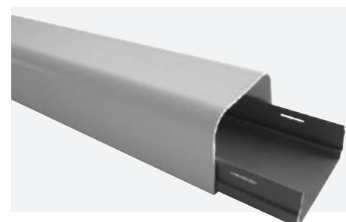

CON65A

65 x 50 mm

24 mt

2530 mm²

20

480

CON70A

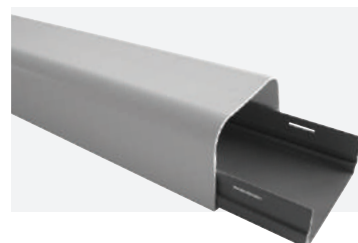

CON70A

70 x 55 mm

20 mt

3056 mm²

20

400

CON80A

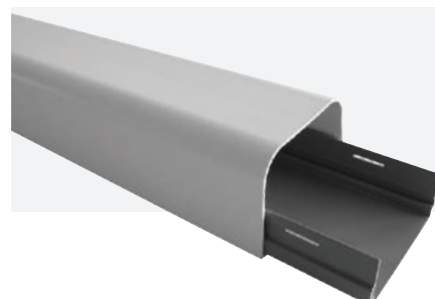

CON80A

80 x 60 mm

16 mt

4018 mm²

20

320

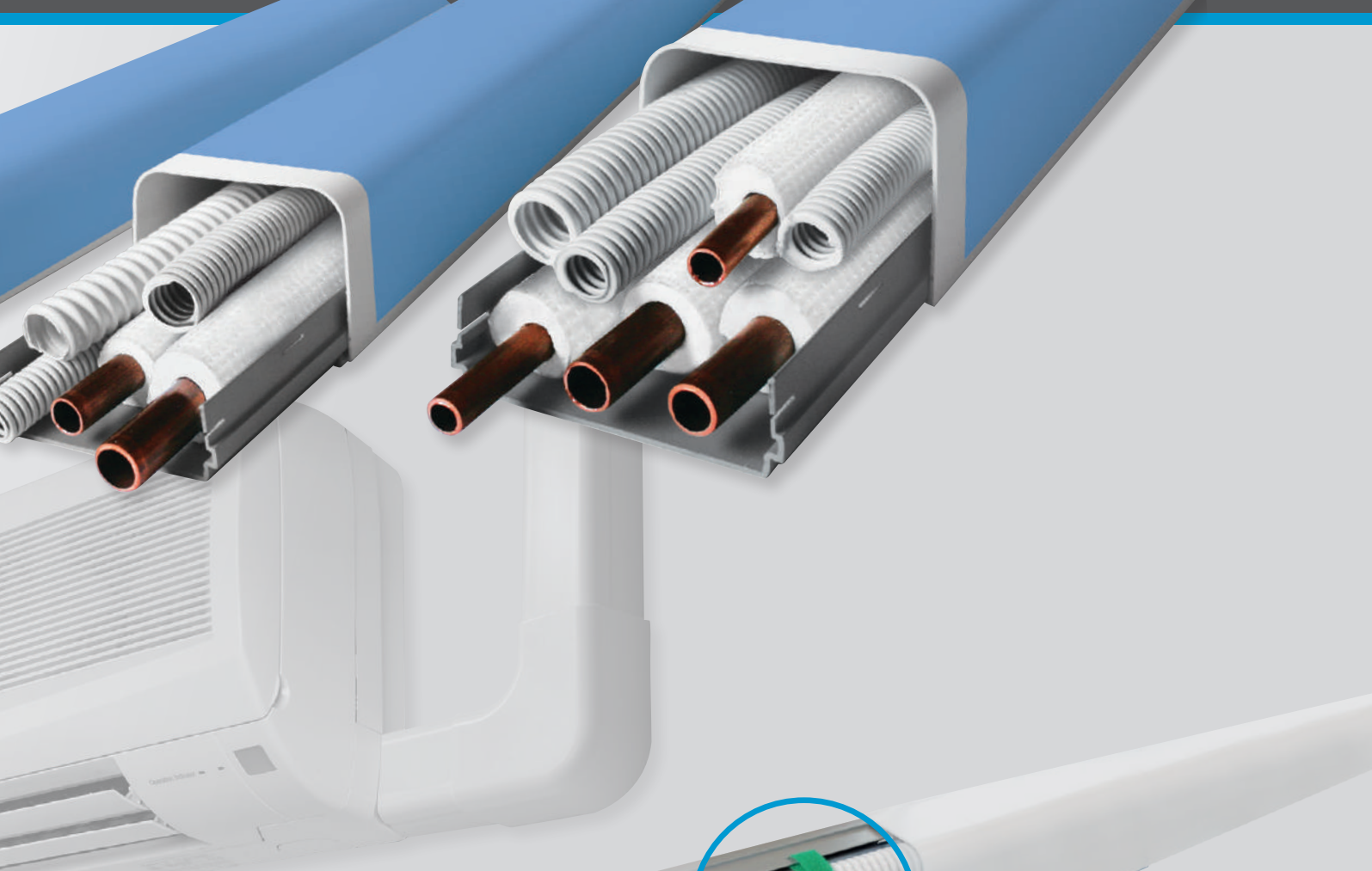

Cable tie
Bride

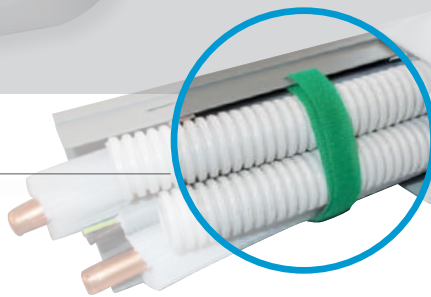

CON90A

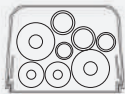
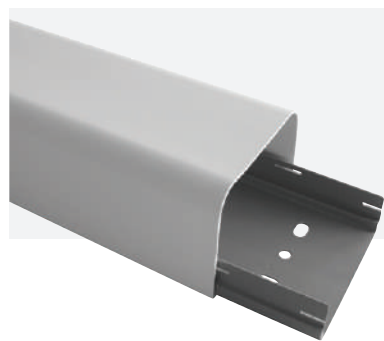

CON90A

90 x 65 mm

16 mt

4830 mm²

20

320

CON125A



CON125A

125 x 75 mm

8 mt

8317 mm²

20

160

SNAP ON LINE | TRUNKING WITH SNAP ON COVER

SNAP ON LINE | GOULOTTE À DÉCLIC

Self-extinguishing PVC, UV stabilized Class 1 (UL94-VO)
 PVC auto-extinguible, Stabilisé UV Classe 1 (UL94-VO)



ARTICON Snap on line is elegant, practical and compact. It is ideal as a complement for internal and external system, available in 6 different sizes in order to satisfy every installation need: MONO, DUAL, MULTISPLIT.

All trunkings are equipped with protective film.

ARTICON Snap on line est élégante, compacte et pratique. Le complément idéal aux systèmes internes et externes, elle est disponible en 6 tailles différentes pour répondre à toute exigence d'installation: MONO, DUAL, MULTISPLIT.

Tous les goulottes sont munis de film de protection.



CON30 Drain pipe trunking
 Goulotte pour tube condensant

		CON30	35 x 30 mm	64 mt	824 mm ²	25	1600
--	--	-------	------------	-------	---------------------	----	------

CON65

		CON65	65 x 50 mm	28 mt	2530 mm ²	20	560
--	--	-------	------------	-------	----------------------	----	-----

CON70

		CON70	70 x 55 mm	24 mt	3056 mm ²	20	480
--	--	-------	------------	-------	----------------------	----	-----

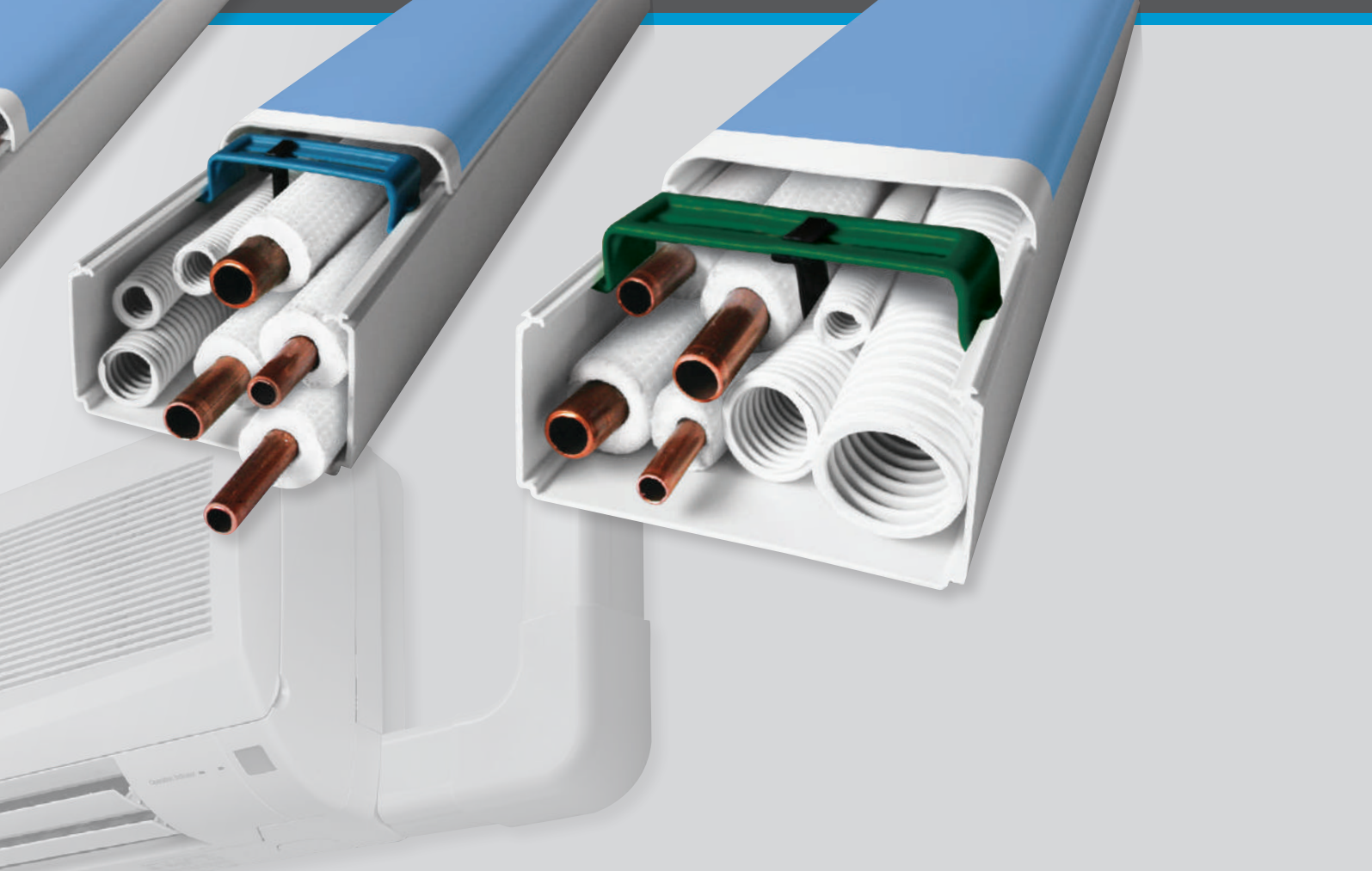

CON80



CON80

80 x 60 mm

20 mt

4018 mm²

20

400

CON90

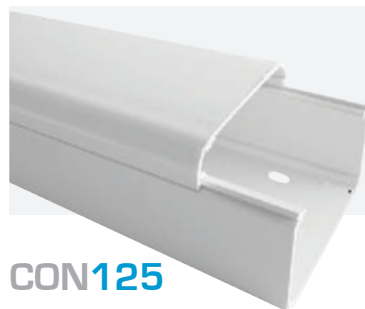

CON90

90 x 65 mm

16 mt

4830 mm²

20

320

CON125



CON125

125 x 75 mm

8 mt

8317 mm²

25

200

TRUNKING ACCESSORIES

ACCESSOIRES POUR GOULOTTES

UNIVERSAL
WRAP / SNAP



CONG cover joint
joint de couvercle



for trunking:
pour goulotte:



CONG30	35 x 30 mm	25
CONG65	65 x 50 mm	25
CONG70	70 x 55 mm	25
CONG80	80 x 60 mm	25
CONG90	90 x 65 mm	25
CONG125	125 x 75 mm	25

CONAI inner bend
angle interne

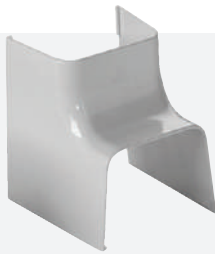

for trunking:
pour goulotte:



CONAI30	35 x 30 mm	20
CONAI65	65 x 50 mm	10
CONAI70	70 x 55 mm	10
CONAI80	80 x 60 mm	10
CONAI90	90 x 65 mm	10
CONAI125	125 x 75 mm	10

CONAE outer bend
angle extérieur



for trunking:
pour goulotte:



CONAE30	35 x 30 mm	20
CONAE65	65 x 50 mm	10
CONAE70	70 x 55 mm	10
CONAE80	80 x 60 mm	10
CONAE90	90 x 65 mm	10
CONAE125	125 x 75 mm	10

CONCP flat bend
courbe plane



for trunking:
pour goulotte:



CONCP30	35 x 30 mm	20
CONCP65	65 x 50 mm	10
CONCP70	70 x 55 mm	10
CONCP80	80 x 60 mm	10
CONCP90	90 x 65 mm	10
CONCP125	125 x 75 mm	10

CONTP end cap
embout



for trunking:
pour goulotte:



CONTP30	35 x 30 mm	20
CONTP65	65 x 50 mm	10
CONTP70	70 x 55 mm	10
CONTP80	80 x 60 mm	10
CONTP90	90 x 65 mm	10
CONTP125	125 x 75 mm	10



CONPAM wall-routing
passage à mur



for trunking:
pour goulotte:



CONPAM65	65 x 50 mm	10
CONPAM70	70 x 55 mm	10
CONPAM80	80 x 60 mm	10
CONPAM90	90 x 65 mm	10
CONPAM125	125 x 75 mm	10

CONCM wall-routing bend
courbe de passage à paroi



for trunking:
pour goulotte:



CONCM65	65 x 50 mm	10
CONCM70	70 x 55 mm	10
CONCM80	80 x 60 mm	10
CONCM90	90 x 65 mm	10
CONCM125	125 x 75 mm	10

CONCT "T" joint deviation
dérivation en "T"



for trunking:
pour goulotte:



CONCT80	80 x 60 mm	6
CONCT90	90 x 65 mm	6
CONCT125	125 x 75 mm	6

CONGU joint with gasket
joint avec garniture



for trunking:
pour goulotte:



CONGU65	65 x 50 mm	10
CONGU70	70 x 55 mm	10
CONGU80	80 x 60 mm	10
CONGU90	90 x 65 mm	10

CONRD trunking reduction
réduction de goulotte



for trunking:
pour goulotte:



use feat
utiliser avec:



CONRD90	90x65 → 70x55 mm	10	CONG90
CONRD125	125x75 → 90x65 mm	10	CONG125

CONVG flange accessory
accessoire convoyeur



for trunking:
pour goulotte:



CONVG110-90	90 x 65 mm	8
--------------------	------------	---

WRAP-AROUND COVER ACCESSORIES

ACCESSORIES POUR GOULOTTE ENVELOPPANTE

VLC10V

green velcro strip for trunking with wrap-around cover 10 x 5 mm
bande velcro vert pour goulotte enveloppante 10 x 5 mm



for trunking:
pour goulotte:

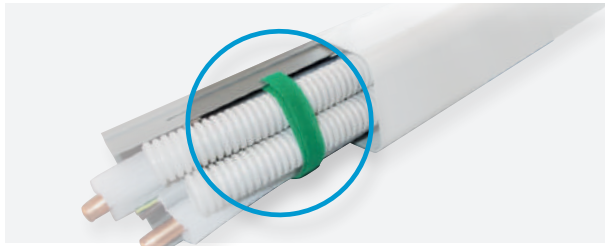

VLC10V

H10 mm x L5 m

65 x 50 mm
70 x 55 mm
80 x 60 mm
90 x 65 mm
125 x 75 mm

1

SNAP-ON COVER ACCESSORIES

ACCESSORIES POUR GOULOTTE A DECLIN

CONTRTB

cross-arm with hose clip for trunking with snap-on cover
traverse avec ailes ferme-tuyau pour goulotte a déclin



for trunking:
pour goulotte:



CONTR65TB
CONTR70TB
CONTR80TB
CONTR90TB
CONTR125TB

65 x 50 mm
70 x 55 mm
80 x 60 mm
90 x 65 mm
125 x 75 mm

25
25
25
25
25

CONPTB

spirit level holder + spirit level set for trunking with snap-on cover
jeux porte-niveau + bulle pour goulotte a déclin



for trunking:
pour goulotte:

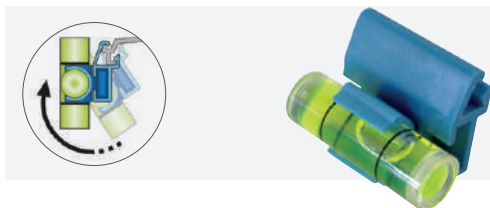

CONPTB

UNIVERSAL

50

CONEVOCUTTER

Duct cutter
Pince coupe

*Formats compatibles
*Capacité de coupe



CONEVOCUTTER

1

Duct cutter for a fast and easy cut both of the base and of the lid: no more imperfection and static dust.

Pince coupe goulotte qui permet de couper facilement la goulotte, sans imperfections et la formation de poussière.

CONEVOLAMA

Cutter blade
Lame de cutter



CONEVOLAMA

1

MINITRUNKING

MOULURES

The minitrunkings satisfy any potential installation necessities concerning electric alimentation. Length 2 mt.

Les Moulures répondent à toutes les exigences d'installation par rapport à l'alimentation électrique. Longueur 2 mt.

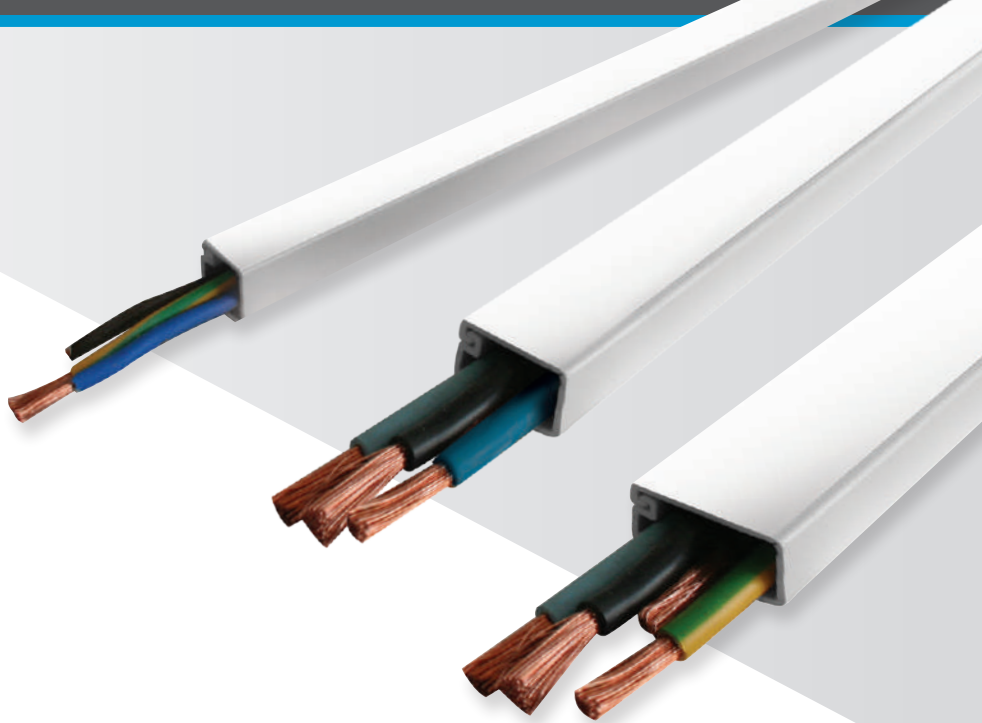

MA211 with **integrated** cover avec couvercle intégré



MA211	10 x 10 mm	240 mt	64 mm ²
-------	------------	--------	--------------------

MA215 with **integrated** cover avec couvercle intégré

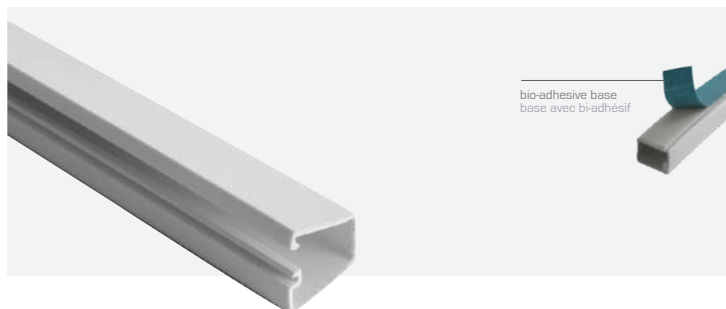

MA215	15 x 10 mm	96 mt	105 mm ²
-------	------------	-------	---------------------

MA221 with **integrated** cover avec couvercle intégré



MA221	20 x 10 mm	120 mt	144 mm ²
-------	------------	--------	---------------------

PRESET BOXES AND SIPHONS

BOITES DE PRÉPARATION ET SIPHONS

CONBOX modular box for condensation drain
boîtier modulaire pour la vidange du condensat



	CONBOX430	427 x 113 x 65 mm	20	25	500	<p>Modular box for condensation drain completed with dx or sx reversible exit for drain-pipe Ø 16-18 and 18-20 mm. 8 refrigerating lines inlet, 2 for side and 4 on the top. Inclined base bottom to avoid condensation. Provided with cutout cardboard against lime.</p> <p>Boîtier modulaire pour la vidange de condensation complété avec droite ou à gauche sortie réversible pour drain-tuyau de Ø 16-18 et 18-20 mm. 8 entrées pour les lignes frigorifiques, deux de chaque côté et 4 sur le côté supérieur. Fond de la base inclinée pour éviter la condensation.</p>
	CONBOX	530 x 113 x 65 mm	20	24	480	

CONBOXRC 90° connectoin drain
raccord de vidange à 90°



	CONBOXRC	Ø 16/18/20	48			
---	----------	------------	----	--	--	--

CONSSC vertical condensation drain siphon anti-odor
siphon vertical de décharge du cond. anti-odeur

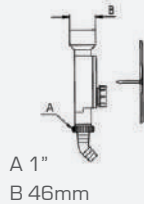

	CONSSC146	 A 1" B 46mm	50	without fastening plate sans plaque de fixation
	CONSSCP146		50	with fastening plate avec plaque de fixation

CONSSCU horizontal condensation drain siphon anti-odor
siphon horiz. de décharge du cond. anti-odeur



	CONSSCU	L60xH77xP50 mm	50	
---	---------	----------------	----	--

RIGID PIPES AND ACCESSORIES

TUYAUX RIGIDES ET ACCESSOIRES

CONTUR condensation drain pipe tuyau d'évacuation des condensats



CONTUR20	Ø 20	20 mt
CONTUR25	Ø 25	20 mt
CONTUR32	Ø 32	20 mt

Material: PVC rigid UV stabilized,
Self-extinguishing Class 1 (UL94-V0)
Bar Length: 2 mt.

Matériel: PVC rigide, stabilisé aux UV
auto-extinguible de classe 1 (UL94-V0).
Longueur de la barre: 2 mt.

CONTURG45

45° bend
coude à 45°



CONTURG4520	Ø 20	20
CONTURG4525	Ø 25	20
CONTURG4532	Ø 32	20

CONTURG90

90° bend
coude à 90°



CONTURG9020	Ø 20	20
CONTURG9025	Ø 25	20
CONTURG9032	Ø 32	20

CONTURM

sleeve joint
manchon de jonction



CONTURM20	Ø 20	20
CONTURM25	Ø 25	20
CONTURM32	Ø 32	20

CONTURR

pipe reduction
réduction dans le tuyau



CONTURR2520	Ø 25 / 20	20
CONTURR3225	Ø 32 / 25	20

CONTURT

"T" deviation
dérivation en "T"



CONTURT20	Ø 20	20
CONTURT25	Ø 25	20
CONTURT32	Ø 32	20

CONTURC

for pipe fastening
pour montage sur tube



CONTURC20	Ø 20	20
CONTURC25	Ø 25	20
CONTURC32	Ø 32	20

FLEXIBLE HOSE AND ACCESSORIES

TUYAUX FLEXIBLES ET ACCESSOIRES

CONFLEX corrugated pipe for condensation
tuyau d'évacuation de condensant ondulé



CONFLEX18.20

Ø 16/18/20

50 mt

90

4500

PE-LD Corrugated pipe
Ø 16-18-20 mm. against UV.
Equipped with male-female
junction per meter - alternating
diameter 16-18 and 18-20
mm.

Tuyau PE-LD ondulé
Ø 16-18-20 mm. contre les UV.
Équipé de mâle-femelle jonction
par mètre - diamètre alternant
16-18 et 18-20 mm.

CONRAC283 three-way fitting for corrugate pipe
raccord à trois voies pour tuyau flexible



CONRAC283

Ø 16/18/20

50

CONRACY "Y" drain connection for corrugate pipe
raccord de vidange en "Y" pour tuyau flexible



CONRACY1618

Ø 16/18

10

CONRACY1820

Ø 18/20

10

CONTRACT "T" joint deviation for corrugate pipe
raccord de vidange en "T" pour tuyau flexible



CONTRACT1618

Ø 16/18

10

CONTRACT1820

Ø 18/20

10

SPIRAL HOSE AND ACCESSORIES

TUYAUX SPIRALÉS ET ACCESSOIRES

CONFLBI Spiraleted pipe for drain condensation
guaine-tuyau pour vidange eau de condensation



CONFLBI116

Ø 16

25 mt

100

2500

Plastic coated self-extinguishing PVC with anti-crush spiral. The smooth interior avoids any stagnation of the condensation. Recommended for external use and NOT subtrack.

CONFLBI118

Ø 18

25 mt

100

2500

Tuyau en PVC plastifié autoextinguible avec spirale antiécrasement. La paroi intérieure lisse évite la stagnation de la condensation.

CONFLBI120

Ø 20

25 mt

100

2500

Recommandé pour une utilisation en extérieur et ne pas sous paroi.

CONRACCT1620 box-pipe drain connection joint
raccord de décharge boîte-tuyau



CONRACCT1620

16 x 20 mm

30

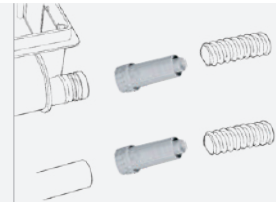

CONISO anti-condensation tape
bande anti-condensation



CONISOGM

50 x 3 - 10 mt

24

CONISOPL

50 x 3 - 10 mt

24

FLOOR SUPPORT

SUPPORTS DE PLANCHER

CONBASE

floor support - external section
base à planç. - unité extérieure



	CONBASE35N	350 x 84 x 80 mm	160	12	16	192	PVC evolution - With slip resistant surface coextruded. Without support cap. PVC evolution - Avec antidérapant coextrudé sur le fond. Sans bouchons.
	CONBASE45N	450 x 84 x 80 mm	160	12	24	288	
	CONBASE100N	1000 x 84 x 80 mm	200	2	-	-	
	CONBASE	420 x 120 x 72,5 mm	250	2	91	182	In polypropylene - Resistant to UV rays and to high temperatures. En polypropylène - Résistant aux rayons UV et à des temp. élevées.

* Maximun admissible load without taking into account any security factor
Charge maximale admissible sans tenir compte de tout facteur de sécurité

CONSTPAR

couple of simple wall brackets
paire de consoles simples



	CONSTPAR42EVO	420 x 400 mm	60+60	1	160	TÜV EVOLUTION
	CONSTPAR46EVO	465 x 400 mm	80+80	1	160	TÜV EVOLUTION PREMONT.

CONSTUN

adjustable universal bracket
support universel réglable



	CONSTUN42EVO	420x400x780 mm	60+60	1	150	TÜV EVOLUTION level / niveau
	CONSTUN46EVO	465 x 400 x 780 mm	80+80	1	150	TÜV EVOLUTION PREMONT. level / niveau
	CONSTUN56EVO	560 x 400 x 800 mm	80+80	1	117	TÜV EVOLUTION PREMONT. level / niveau

CONSTUN

adjustable universal bracket
support universel réglable



CONSTUN48PLUS

480 x 400 x 800 mm

80+80

1

104

TÜV

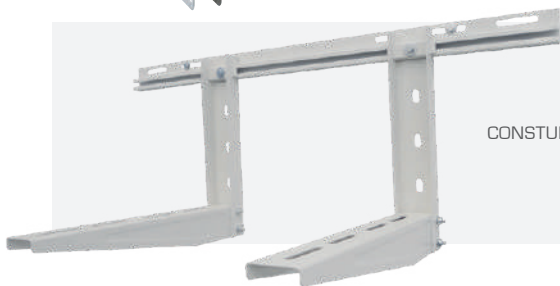

CONSTUN56PLUS

560 x 400 x 960 mm

150+150

1

100

TÜV

CONAVM

anti-vibration kit
kit anti-vibration



CONAVM30

30 x 20 mm

42

10 kit

1 kit contains
4 pieces

CONAVM53

40 x 40 mm

65

10 kit

1 jeu contient
4 pièces

CONAVP

anti-vibration kit
kit anti-vibration



CONAVP20

48 x 20 mm

45

10 kit

1 kit contains
4 pieces
1 jeu contient
4 pièces



CONAVP53

40 x 40 mm

65

10 kit

1 kit contains
4 pieces
1 jeu contient
4 pièces

CONCAP

covering garment
capot



CONCAP725

700 x 265 x 540 mm

10

CONCAP825

800 x 265 x 540 mm

10

CONCAP836

860 x 330 x 610 mm

10

CONCAP936

950 x 330 x 610 mm

10

CONCAP937

950 x 380 x 750 mm

10

TRUNKING ACCESSORIES

ACCESSOIRES POUR GOULOTTES



WITH WRAP-AROUND COVER

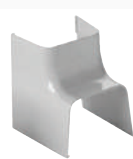

INNER
BENDS

OUTER
BENDS

90° FLAT
BENDS

T-JOINT
DEVIATIONS

WALL
ROUTINGS



65 x 50 mm

CON65A

CONAI65

CONAE65

CONCP65

CONPAM65



70 x 55 mm

CON70A

CONAI70

CONAE70

CONCP70

CONPAM70



80 x 60 mm

CON80A

CONAI80

CONAE80

CONCP80

CONCT80

CONPAM80



90 x 65 mm

CON90A

CONAI90

CONAE90

CONCP90

CONCT90

CONPAM90



125 x 75 mm

CON125A

CONAI125

CONAE125

CONCP125

CONCT125

CONPAM125



WITH SNAP-ON COVER

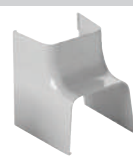

INNER
BENDS

OUTER
BENDS

90° FLAT
BENDS

T-JOINT
DEVIATIONS

WALL
ROUTINGS



35 x 30 mm

CON30

CONAI30

CONAE30

CONCP30



65 x 50 mm

CON65

CONAI65

CONAE65

CONCP65

CONPAM65



70 x 55 mm

CON70

CONAI70

CONAE70

CONCP70

CONPAM70



80 x 60 mm

CON80

CONAI80

CONAE80

CONCP80

CONCT80

CONPAM80

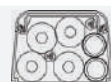

90 x 65 mm

CON90

CONAI90

CONAE90

CONCP90

CONCT90

CONPAM90



125 x 75 mm

CON125

CONAI125

CONAE125

CONCP125

CONCT125

CONPAM125

							
WALL BENDS	END CAPS	COVER JOINTS	TRUNKING-INNER UNIT JOINTS + GASKET	REDUCTIONS	FLANGE ACCESSORY		THIN VELCRO TAPE
CONCM65	CONTP65	CONG65	CONGU65				VLC10V
CONCM70	CONTP70	CONG70	CONGU70				VLC10V
CONCM80	CONTP80	CONG80	CONGU80				VLC10V
CONCM90	CONTP90	CONG90	CONGU90	CONRD90 90/70	CONVG110-90		VLC10V
CONCM125	CONTP125	CONG125		CONRD125 125/90			VLC10V
							
WALL BENDS	END CAPS	COVER JOINTS	TRUNKING-INNER UNIT JOINTS + GASKET	REDUCTIONS	FLANGE ACCESSORY	CROSS-ARMS + TUBE-HOLDING CLIP	LEVEL SET
	CONTP30	CONG30					CONPTB
CONCM65	CONTP65	CONG65	CONGU65			CONTR65TB	CONPTB
CONCM70	CONTP70	CONG70	CONGU70			CONTR70TB	CONPTB
CONCM80	CONTP80	CONG80	CONGU80			CONTR80TB	CONPTB
CONCM90	CONTP90	CONG90	CONGU90	CONRD90 90/70	CONVG110-90	CONTR90TB	CONPTB
CONCM125	CONTP125	CONG125		CONRD125 125/90		CONTR125TB	CONPTB

GENERAL TERMS

CONDITIONS GÉNÉRALES

1 - Prices and conditions only become binding at the time of acceptance of the order, by us, with written confirmation. Your purchase order is an implicit acceptance of our General Conditions of Sale by You.

2 - The conditions and other commitments entered into the quotation by us are only valid if an order is placed for everything which is included in that quotation.

3 - Estimates, outline designs, etc. attached to the quotation are our exclusive property and may not therefore be communicated to third parties without our written authorisation.

4 - Any modifications to the quotation and to these general supply conditions must be in writing and are limited to what is expressly agreed.

WEIGHTS - DIMENSIONS - TECHNICAL DATA

5 - Estimates, designs and technical data indicated in our catalogues, price lists and quotations are only approximate until they have been confirmed or replaced by definitive data, either in part or in total, at the time of the order.

PRICES

6 - Prices and discounts on list prices and quotations are subject to variation according to market requirements or in line with variations in the cost of raw materials or labour, without any prior notice to our Customers. Prices are EXW Incoterms 2000; transport costs, customs, excise and any other types of duty are always payable by the Customer, unless otherwise agreed in writing. Carriage is free of charge for orders with a minimum net value of € 1.000,00 inside Italy.

PACKING AND TRANSPORT

7 - Packaging, which is invoiced at cost, is non-returnable. Our Company standard condition of delivery is EXW and therefore cannot be held responsible for missing or irregular deliveries by carriers, being explicitly understood that, even if the Company helps organize the shipment to the Customer's premises, the goods travel at the entire risk of the Purchaser. Any return of goods must first be authorised by our Company and goods must be returned free of any cost to our Factory warehouses.

DELIVERY TIMES

8 - Agreed delivery times are indicative and not legally binding and are subject to the clause "unless sold" for goods indicated as ready; they are valid only in normal working and supply conditions. Our Company shall in no circumstances or for any reason be liable to pay compensation of any kind of direct or indirect damage due to late deliveries.

PAYMENTS

9 - Payment terms and conditions must be agreed in writing or, failing this, shall be understood to be net cash on delivery of the goods. The goods remain property of Canalplast until the Customer pays for them. In the event of late payment, the Customer undertakes to pay interest on delayed payment equivalent to the average market rate applied by Financial Institutions, plus 4%. If the purchaser fails to comply, even partially, with any of the conditions agreed for collection of the goods or for settlement and payment of individual invoices, our Company has the right to immediately suspend further deliveries and consider itself free of any contractual obligation, while retaining all its rights relating to failure to comply with the contract. Unless expressly agreed otherwise, payments must always be made directly to our Company.

CLAIMS

10 - Any claims relating to the supply of goods must reach us within 12 days of receipt of such goods, after which time they will no longer be accepted. Every claim must be based on concrete facts in order to be taken into consideration. We shall be entitled, at our discretion, to take back or replace goods which the Customer demonstrates to be faulty, but will not accept any costs for repairs or modifications which have been made without our authorisation. It remains understood that any claims on any single consignment of goods will have no effect on the balance of the order or the obligation, or on payment for other goods already received without complaint.

WARRANTY

11 - The warranty we offer for products made by us is 12 months from the date of the corresponding invoice and, during this period, we undertake to repair or replace free of charge in our workshops any parts or equipment which are unusable due to defective materials or workmanship. In all cases, we reserve the right to decide, at our entire discretion, whether repair or replacement is most appropriate. We however exclude the possibility of sending our personnel to make on-site inspections to installations where our equipment is installed, except in cases where, at our entire discretion, we believe it is necessary to check the operating conditions to which our equipment has been subjected.

12 - Our warranty is naturally valid provided that the Customer has used and treated our equipment with due care, that the equipment has not been misused or modified and that all the technical requirements contained in our price lists and instruction sheets have been complied with. The warranty does not cover parts which, due to the nature of the material with which they are made or to their specific use, are subject to premature wear; damage due to normal wear and tear is also excluded.

13 - The Customer must send written notification of failures and defects, giving an exact description of their nature and we shall arrange, within the necessary time required, repairs and replacement under the above terms and conditions. Material for repair or replacement must be delivered to us, carriage paid.

14 - With the repair or replacement of the equipment or any of its parts which were defective, our Company shall be relieved of all and any responsibility of any kind, while the Customer shall consider him/herself entirely satisfied by this fact and shall renounce any request for damages and costs. In certain cases, we may allow the Customer to arrange any necessary repairs or replacements, it being understood that our only obligation will be to refund any out of pocket expenses accepted as essential to put our equipment in working order.

15 - In the event of disputes of a technical nature, the parties shall submit to the opinion of an expert to be appointed by joint agreement or, if agreement cannot be reached on the appointment, selected by the President of the Milan Court.

16 - We shall not accept any expenses which may have been borne by the Customer, even within the warranty period, without our prior written authorisation.

17 - Our Company reserves the right to use, in the manufacture of its equipment, any material it deems the most suitable and to make any modifications it deems necessary to the shape, weight or dimensions of its products.

DISPUTES

18 - All agreements, even if entered into with foreign companies or individuals or for materials supplied abroad, shall be governed solely by current Italian law. The Milan courts shall have sole jurisdiction over any dispute which may arise in relation to the performance of the Agreement, including by way of exception to sections 31 et seq. of the Civil Procedure Code, and the Customer shall not be entitled to file proceedings before the courts of any other place, even in the case of proceedings involving a guarantee or its alibi pendens, without prejudice to the supplier company's right to take proceedings, as plaintiff, in the courts of the Customer's place of residence, whether in Italy or abroad.

19 - Disputes do not in any way relieve the Customer from having to comply with agreed payment terms and do not imply any extension of the terms agreed. The marks Articon and Canalplast are of ownership of Canalplast S.p.A. Except our authorization, the total or partial reproduction of the present catalogue is distrusted.

1 - Prix et conditions entrent en vigueur lors de notre acceptation de la commande par une confirmation écrite. La commande d'achat du client constitue une acceptation implicite des Conditions de Vente générales, par le même client.

2 - Les conditions et les autres obligations assumées par nous avec l'offre, seront valable uniquement dans le cas où elles sont étendues à tout ce qui est présenté dans la commande.

3 - Demande de devis, dessins techniques, et tous ce que est adjoind à l'offre, sont de notre propriété et doit ils ne peuvent pas être divulgués à tiers sans notre permission écrite.

4 - Toute modification apportée à l'offre et aux conditions générales de l'offre, doit être faite pour écrit et doit être limitée dans la mesure expressément convenue.

POIDS - DIMENSIONS - DONNÉES TECHNIQUES

5 - Budget des dépenses, plans, dessins, spécifications et photos présentées dans les catalogues, listes de prix et les offres, ne sont que approximatifs, jusqu'à quand ils sont confirmées ou remplacées par des données finales en totalité ou en partie, au moment de la commande.

PRIX

6 - Prix et remises sur tarifs des prix sont sujets à changement en fonction des besoins du marché ou en corrélation avec l'évolution du coût des matières premières ou du travail, sans préavis d'aucune sorte. Ils sont Ex Works (EXW Incoterms-2010), les coûts de transport, droits de douane et taxes de toute nature, sont toujours payés par l'acheteur, sauf accord contraire écrit.

EMBALLAGE ET TRANSPORT

7 - L'emballage, qui est facturé au prix de coût, ne sera pas accepté de retour. La condition de livraison normale de notre société est EXW et donc nous ne pourrions pas être tenus pour responsables de livraisons manquantes ou irrégulières par les transporteurs, il est expressément entendu que, bien que la société aide à organiser l'expédition au domicile du client, les marchandises voyagent toujours aux risques et périls du client. Tout retour de marchandise doit être préalablement autorisé par notre société et sans aucune dépense rendu aux entrepôts de notre usine.

DÉLAI DE LIVRAISON

8 - Le délai de livraison convenus sont indicatifs et non juridiquement contraignant, et conformément à la clause «à moins que le vendus» pour marchandise indiquée comme prête, ne sont valables que dans des conditions normales de travail et d'approvisionnement. En aucun cas et pour une raison quelconque, notre Société est tenue à payer aucune indemnité pour les dommages directs ou indirects résultant de retards de livraison.

PAIEMENTS

9 - Les conditions et le paiement doivent se faire par accord écrit ou, à défaut, ils seront entendus nets par comptants à la livraison. Les marchandises restent la propriété de Canalplast jusqu'à quand le client a payé pour cela. En cas de retard de paiement, le client s'engage à payer les intérêts moratoires au taux moyen du marché pratiqués par les institutions financières, plus 4%. Si l'acheteur ne respecte pas, même en partie, une des conditions stipulées pour le retrait de la marchandise ou pour le règlement du paiement des factures, notre Société sera en droit de suspendre immédiatement autres livraisons et libre de toutes obligations contractuelles, sans préjudice tout droit en fonction de l'échec du contrat. Sauf convention expresse contraire de les paiements doivent toujours être adressées directement à notre Société.

PLAINTES

10 - Toute plainte concernant la fourniture de biens doivent être reçues dans les 12 jours suivant la réception des marchandises, après quoi il ne sera plus acceptée. Chaque demande doit être fondée sur les données afin d'être prises en compte. Nous pourrions, à notre discrétion, accepter de retour ou remplacer ce que le client s'avère défectueux, mais nous ne reconnaitrons pas aucun frais pour les réparations effectuées ou modifications qui ont été apportées sans notre permission. Il est entendu que toute créances sur chaque envoi de marchandises n'aura aucun effet sur le reste de l'ordre ou l'engagement, ou le paiement des marchandises déjà reçues et pas protestées.

GARANTIES

11 - La garantie que nous offrons sur nos matériaux de construction a une durée de 12 mois à compter de la date de la facture et il est entendu que durant cette période nous nous engageons à réparer ou à remplacer gratuitement dans notre usine de pièces ou équipements qui, par manque de construction ou matériel, soit inutilisable. Dans tous les cas, nous pouvons décider à notre seule discrétion si la réparation ou le remplacement est la solution plus avantageuse. Nous excluons cependant, d'envoyer notre personnel à visiter les installations qui ont utilisé nos dispositifs, sauf dans les cas où, à notre seule discrétion, nous le jugeons nécessaire pour vérifier les conditions d'exploitation aux quelles nos appareils sont étés soumis.

12 - Notre garantie reste valable si nos appareils ont été utilisés par le client de façon correcte, n'ont pas étés endommagés, altérés ou modifiés, et ont été utilisés selon toutes les règles techniques recommandées. La garantie ne s'applique pas à ces pièces qui sont soumises à une usure prématurée, comme exclut également les défauts causés par la consommation.

13 - Le client doit donner un préavis écrit de défauts et les défauts signalés par rapport à leur exacte nature et nous ferons les réparations nécessaires et les remplacements dans les circonstances et dans termes les plus rapides. Le matériel à réparer ou remplacer, nous sera envoyé Franco notre usine.

14 - Notre entreprise, avec la réparation ou le remplacement d'équipement ou des parties défectueux, sera exonérée de toute responsabilité, alors que l'acheteur est réputé pleinement reconnu et il fait renonce à toute réclamation pour dommages et dépenses. Dans certains cas, nous pouvons permettre à l'acheteur de fournir des réparations ou substitutions, qu'il soit la seule obligation de notre part à rembourser les dépenses reconnues comme indispensables pour la mise en efficience de nos appareils.

15 - En cas de divergences, les parties s'en remettront à l'opinion d'un expert qui sera désigné par accord mutuel ou, en cas de divergence de la nomination, choisi par le Président de la Cour de Milan.

16 - Nous ne reconnaitrons pas aucune dépense que l'acheteur avait fait valoir, même dans la période de garantie, sans notre autorisation écrite préalable.

17 - Notre Société se réserve le droit d'utiliser dans la fabrication de ses équipements tout matériel jugée le plus approprié et de faire des changements dans la forme, le poids ou la taille de ses produits qu'elle juge appropriée.

LITIGES

18 - Le contrat, bien que signé avec des sociétés ou citoyens étrangers, est réglé exclusivement par la législation italienne actuelle. La compétence pour tout litiges dans le cadre de l'exécution du contrat doit reposer uniquement au Tribunal de Milan.

19 - Tous les litiges ne dispense en aucun cas le Client de se conformer aux conditions de paiement et n'impliquent aucune extension des conditions convenues. Les marques Articon et Canalplast sont la propriété de Canalplast SpA. Sauf notre permission, on défend toute reproduction totale ou partielle de ce catalogue.





CANALPLAST S.P.A. Via Tolstoj, 65 - 20812 Limbiate (MB) - Italy
Telefono +39 02 9906421 • Fax +39 02 99055900

WEB: www.canalplast.it
E-MAIL: info@canalplast.it