

Cantak®



SECCIONADOR ON-OFF (con brazo) LW30-63-300040(3P)

INFORMACIÓN GENERAL

- Corriente de trabajo: 63A
- Panel: 64x64mm, Enclavamiento en puerta
- Código de diagrama: 300040(3P)
- Color: Rojo/Amarillo/Negro/Azul
- Maneta: Tipo GS
- Grado de protección: IP20
- Certificaciones: CE, TUV, ISO, CCC, RoHS









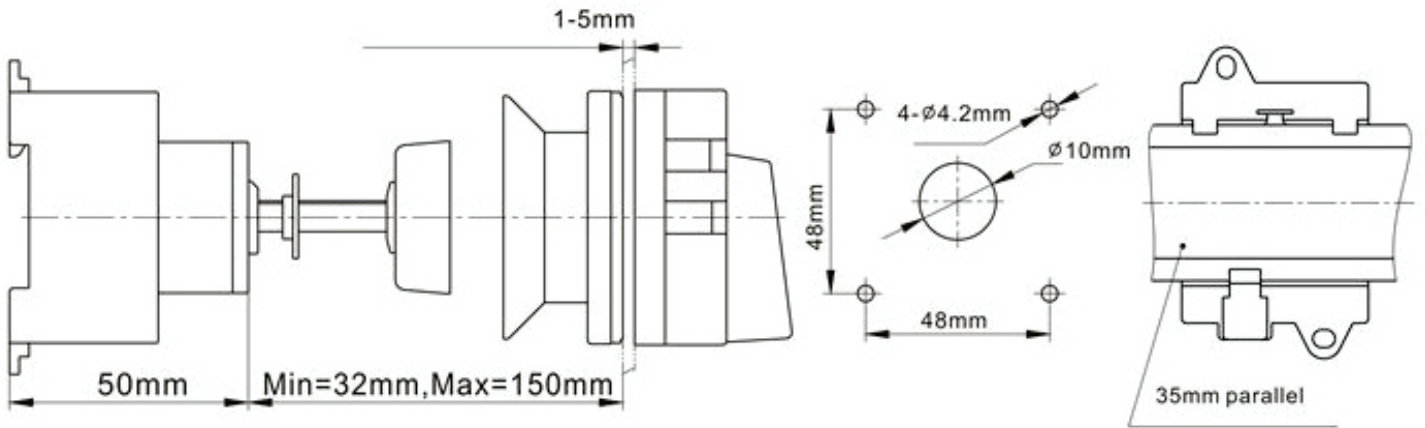

ESPECIFICACIONES

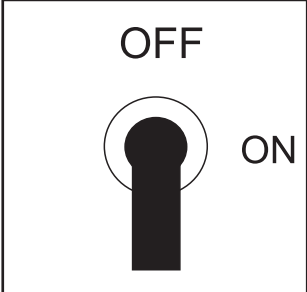
Especificaciones	LW30-63			
Tensión de aislamiento designada	660/690			
Corriente nominal Térmica	63			
Tensión nominal de trabajo			240	440
CORRIENTE NOMINAL DE TRABAJO				
AC-21A			63/-	63/-
AC-22A			63/-	63/-
AC-23A			43/11	43/22
AC-3			36/11	36/18.5

Cantak®

**SECCIONADOR
ON-OFF (con brazo)
LW30-63-300040(3P)**



300040(3P)		1	3	5	7
 OFF ON					
					
3P	90°				
OFF					
ON		X	X	X	

